



VIBRATEURS ÉLECTRIQUES MVE 3000 RPM OLI



> DOCUMENTS  
D'INSTALLATION  
& MAINTENANCE  
VIA LE QR CODE

- Moteurs adaptés à l'industrie agro-alimentaire, chimique, environnementale et pharmaceutique.
- A partir de 66 Kg. et jusqu'à 9T. de force centrifuge. (Réglable par ajustement des masselottes)



\*Moment de travail = 2x moment statique.

		SPECIFICATIONS MECANIQUES				SPECIFICATIONS ELECTRIQUES				
Tours /Min	Modèle	Force centrifuge		Moment Statique *	Poids	Voltage nominal	Courant Maximal	Connexion Borniers	Puissance Maximale	
50 Hz	Type/rpm	KG	N	kgmm	KG	V	A	Wye	kW	
T R I P H A S E	3000	MVE 60/3	66	647	6,5	4	400	0.25	Y	0.09
		MVE 100/3	98	961	10	5	400	0.25	Y	0.09
		MVE 200/3	187	1834	18,5	7	400	0.35	Y	0.15
		MVE 300/3	321	3149	32	10	400	0.52	Y	0.25
		MVE 400/3	407	3993	40	10	400	0.58	Y	0.27
		MVE 500/3	530	5199	51,5	16	400	0.96	Y	0.50
		MVE 700/3	758	7436	74,5	17	400	1.25	Y	0.59
		MVE 800/3	794	7789	78,5	21	400	1.45	Y	0.70
		MVE 1200/3	1005	9859	101,5	22	400	1.85	Y	0.95
		MVE 1300/3	1355	13293	133	22	400	2.44	Y	1.30
		MVE 1600/3	1601	15706	156,5	57	400	2.94	Y	1.54
		MVE 2000/3	2027	19885	184	53	400	3.75	Y	2.10
		MVE 2300/3	2302	22583	230	54	400	4.44	Y	2.40
		MVE 3200/3	3252	31902	340,5	103	400	5.30	v	2.76
		MVE 4000/3	4033	39564	397	107	400	5.30	Y	2.90
MVE 5000/3	5009	49138	516	111	400	7.22	Y	4.00		
MVE 6500/3	6510	63863	648	228	400	9.50	Y	5.55		
MVE 9000/3	9025	88535	898	240	400	11.50	Y	6.60		

Nous nous réservons le droit de modifier les spécifications et dimensions sans préavis.



**VIBRATEURS ÉLECTRIQUES MVE 3000 RPM OLI**

DIMENSIONS (mm)													
Modèle	A	B	C	D	E	F	ØG	H	I	L	M	N	Fig.
-	-	-	-	-	-	-	-	-	-	-	-	-	-
MVE 60/3	62-74 33	106 83-102	213	130	135	11	9 7	50	96	107	45	85	1
MVE 100/3	62-74 33	106 83-102	213	130	135	11	9 7	50	96	107	45	85	1
MVE 200/3	62-64 65 115 135	106 140 135 115	222	164	140	25	9 13 11 11	82	116	159	55	110	3
MVE 300/3	80 90 124 135	110 125 110 115	254	150	173	15	11 13 11 11	79	150	166	42	134	4
MVE 400/3	80 90 124 135	110 125 110 115	274	150	173	15	11 13 11 11	79	150	166	52	134	4
MVE 500/3	105	140	330	170	196	20	13	92	169	166	78	158	5
MVE 700/3	105	140	330	170	196	20	13	92	169	166	78	158	5
MVE 800/3	120	170	321	208	210	22	17	96	185	192	62	170	5
MVE 1200/3	120	170	321	208	210	22	17	96	185	192	62	170	5
MVE 1300/3	120	170	321	28	210	22	17	96	185	192	62	170	5
MVE 1600/3	140	190	402	230	260	26	17	124	240	218	90	222	5
MVE 2000/3	140	190	402	230	260	26	17	124	240	218	90	222	5
MVE 2300/3	140	190	402	230	260	26	17	124	240	218	90	222	5
MVE 3200/3	155	255	516	304	314	30	25	147	285	277	117	264	5
MVE 4000/3	155	255	516	304	314	30	25	147	285	277	117	264	5
MVE 5000/3	155	255	564	304	314	30	25	147	285	277	141	264	5
MVE 6500/3	200	320	624	385	402	40	28	203	394	360	130	378	5
MVE 9000/3	200	320	624	385	402	40	28	203	394	360	130	378	5

Nous nous réservons le droit de modifier les spécifications et dimensions sans préavis.

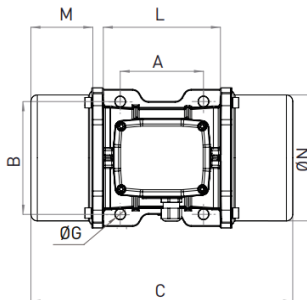
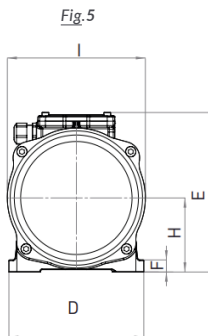
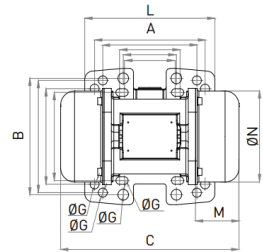
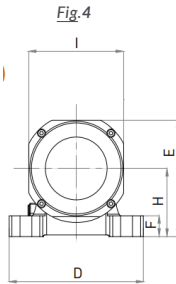
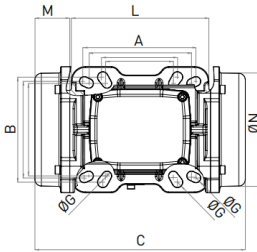
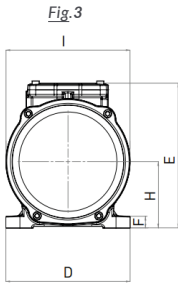
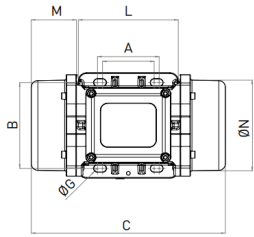
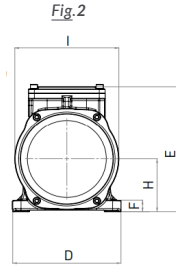
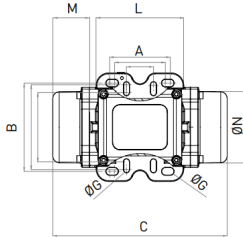
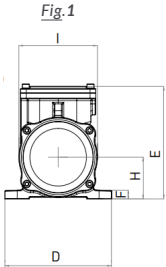

VIBRATEURS ÉLECTRIQUES MVE 3000 RPM OLI



Nous nous réservons le droit de modifier les spécifications et dimensions sans préavis.